

Electrical Characteristics										
Frequency	Hz	50				60				
Voltage (parallel star)	V	380	400	415	440	415	440	460	480	
Rated power class H	kVA	550	550	540	500	570	630	660	660	
	kW	440	440	432	400	456	504	528	528	
Rated power class F	kVA	500	500	490	454	515	570	600	600	
	kW	400	400	392	363	412	456	480	480	
Regulation with DER1		±1% with any power factor and speed variations between -5% +30%								
Insulation class		H								
Execution		Brushless								
Stator winding		12 ends								
Rotor		with damping cage								
Efficiencies class H	4/4	%	94,1	94,2	93,9	93,7	94,5	95	95,1	95,2
(see graph. for details)	3/4	%	94,3	94,6	94,5	94,2	94,9	95,1	95,2	95,5
	2/4	%	93,6	93,7	93,7	93,5	94,5	94,6	94,7	94,8
	1/4	%	90,2	90	89,8	89,7	91	91,1	91,1	91
Reactances (f. l.cl. F)	Xd	%	312,5	282	257,2	211,9	325,8	320,3	307,1	282
	Xd'	%	31,2	28,2	25,7	21,2	32,6	32,0	30,7	28,2
	Xd''	%	20,7	18,7	17,1	14,0	21,6	21,2	20,4	18,7
	Xq	%	168,4	152	138,6	114,2	175,6	172,7	165,5	152
	Xq'	%	168,4	152	138,6	114,2	175,6	172,7	165,5	152
	Xq''	%	26,8	24,2	22,1	18,2	28,0	27,5	26,4	24,2
	X ₂	%	23,7	21,4	19,5	16,1	24,7	24,3	23,3	21,4
	X ₀	%	3,5	3,2	2,9	2,4	3,7	3,6	3,5	3,2
Short Circuit Ratio	Kcc		0,30	0,42	0,62	1,10	0,22	0,26	0,30	0,42
Time Constants	Td'	sec.	0,138							
	Td''	sec.	0,0185							
	Tdo'	sec.	2,85							
	Tα	sec.	0,03							
Short Circuit Current Capacity		%	>300				>350			
Excitation at no load	Amp.		0,5	0,7	1,1	1,3	0,4	0,5	0,6	0,7
Excitation at full load	Amp.		3,2	3,3	3,6	3,8	2,9	3	3,1	3,2
Overload (long-term)		%	1 hour in a 6 hours period 110% rated load							
Overload per 20 sec.		%	300							
Stator Winding Resistance (20 °C)	Ω		0,010							
Rotor Winding Resistance (20 °C)	Ω		6,025							
Exciter Resistance (20 °C)	Ω		Rotor : 0,317				Stator : 8,85			
Heat dissipation at f.l.cl.H	W		27588	27091	28064	26894	26540	26526	27205	26622
Telephone Interference			THF < 2%				TIF < 40			
Radio interference			EN61000-6-3, EN61000-6-1. For others standards apply to factory							
Waveform Distors.(THD) at f. load	LL/LN %		2,3 / 2,4							
Waveform Distors.(THD) at no load	LL/LN %		2,5 / 2,5							
Mechanical characteristics										
Protection			IP 21 (other protection on request)							
DE bearing			6322							
NDE bearing			6318.2RS							
Weight of wound stator assembly	kg		477							
Weight of wound rotor assembly	kg		297,5							
Weight of complete generator	kg		1324							
Maximun overspeed	rpm		2250							
Unbalanced magnetic pull at f.l.cl.F	kN/mm		6,1							
Cooling air requirement	m³/min		54				64,8			
Inertia Constant (H)	sec.		0,170				0,204			
Noise level at 1m/7m	dB(A)		94 / 82				98 / 88			

All technical data are to be considered as a reference and they can be modified without any notice.

This document is a propriety of Mecc Alte S.p.A.. All rights reserved.

50 Hz

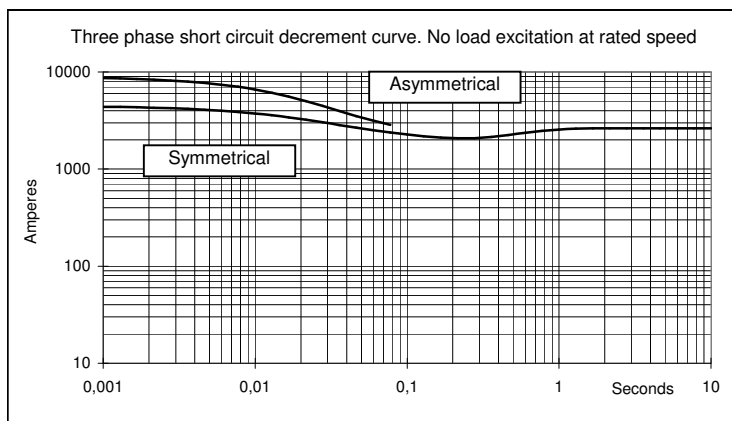
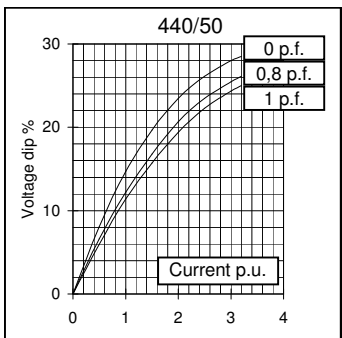
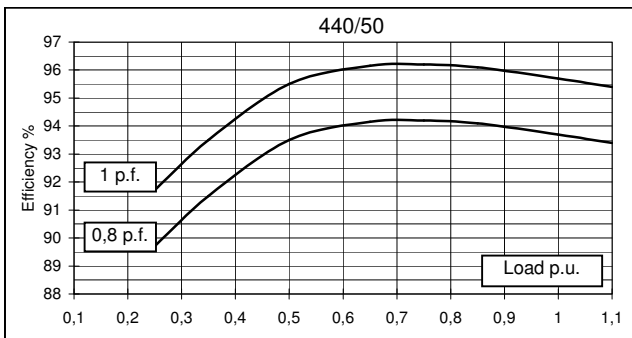
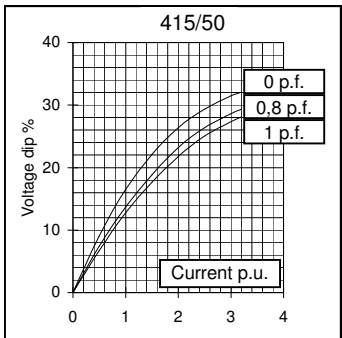
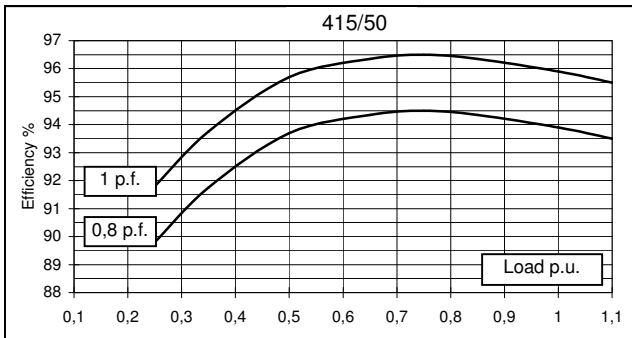
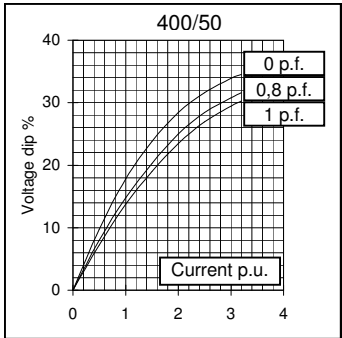
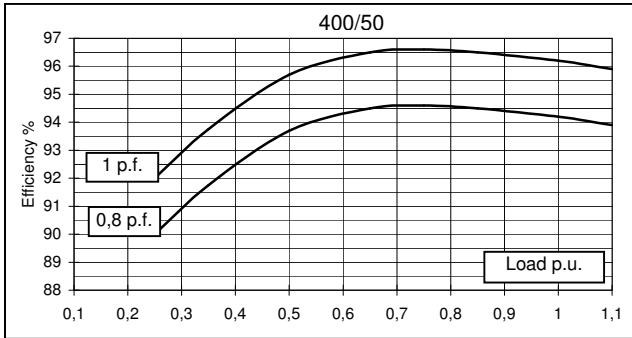
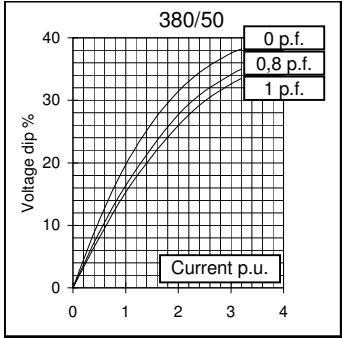
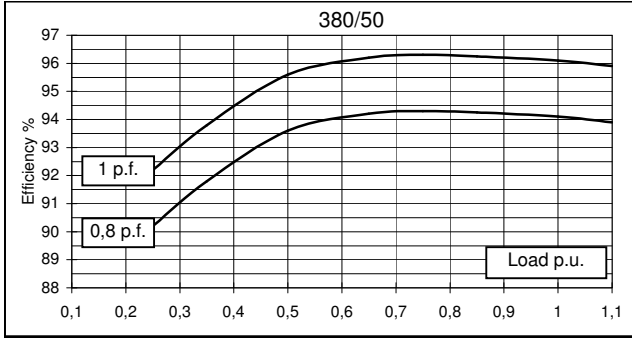

60 Hz

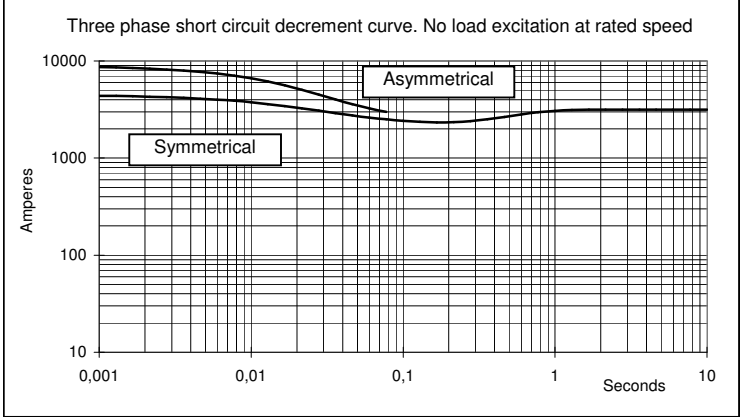
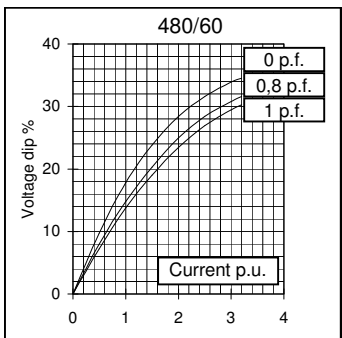
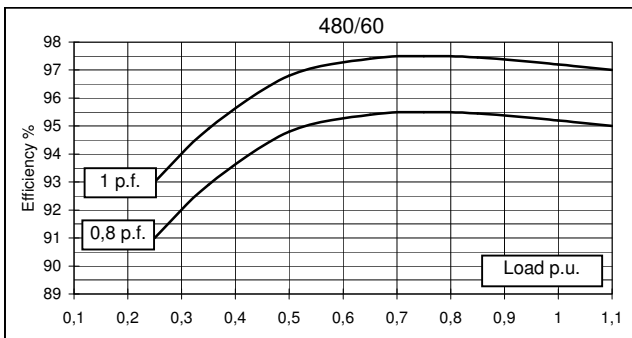
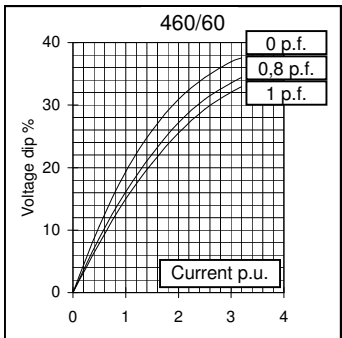
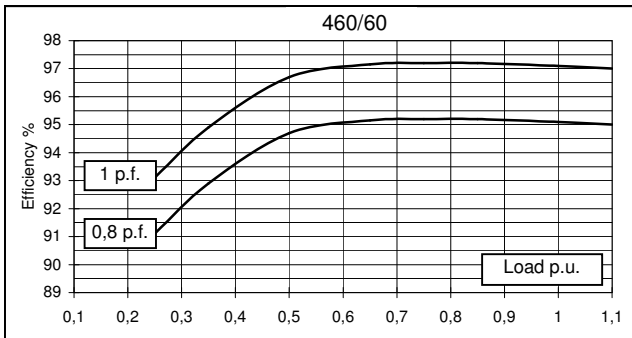
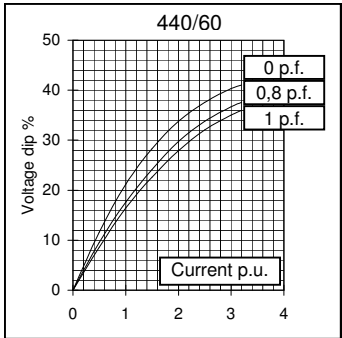
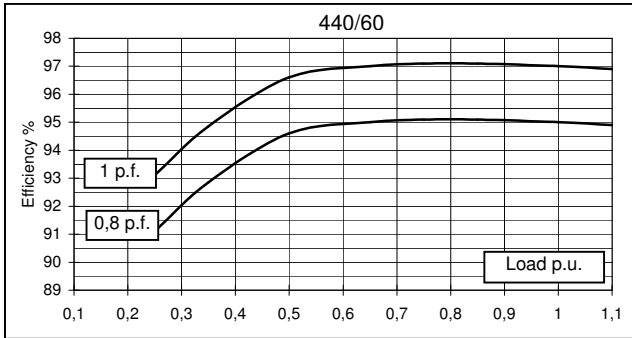
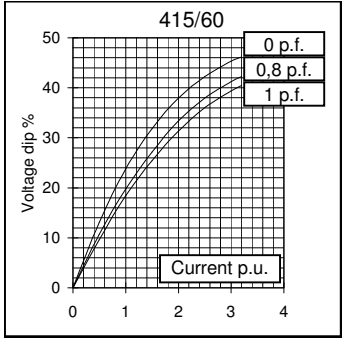
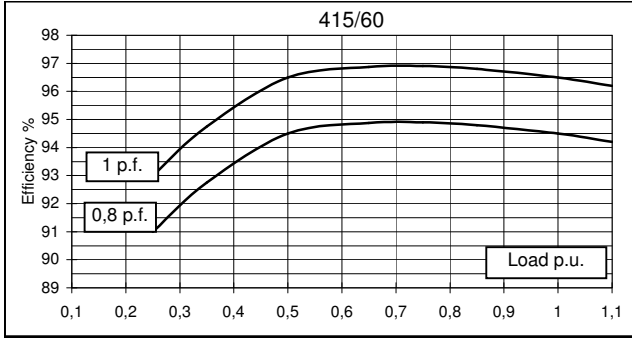

SINGLE BEARING MOMENTS OF INERTIA

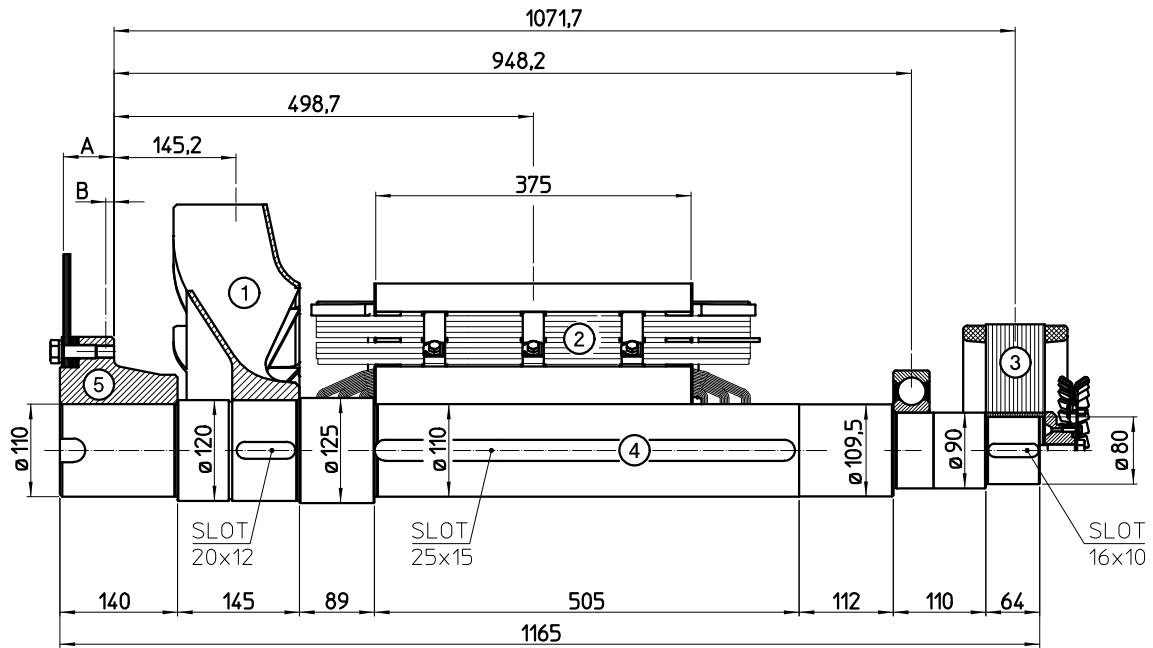

COMPONENT	WEIGHT kg	J kgm ²
1 FAN	10,2	0,335
2 MAIN ROTOR	297,5	6,332
3 EX. ROTOR	35	0,562
4 SHAFT	84,2	0,129
TOTAL	426,9	7,358

Sae No	SHAFTS COUPLING FLEX PLATE			
	A	B	WEIGHT kg	J kgm ²
14	60	9,6	41,4	0,511
18	50	6,6	45,1	0,858

SINGLE BEARING DIMENSIONS

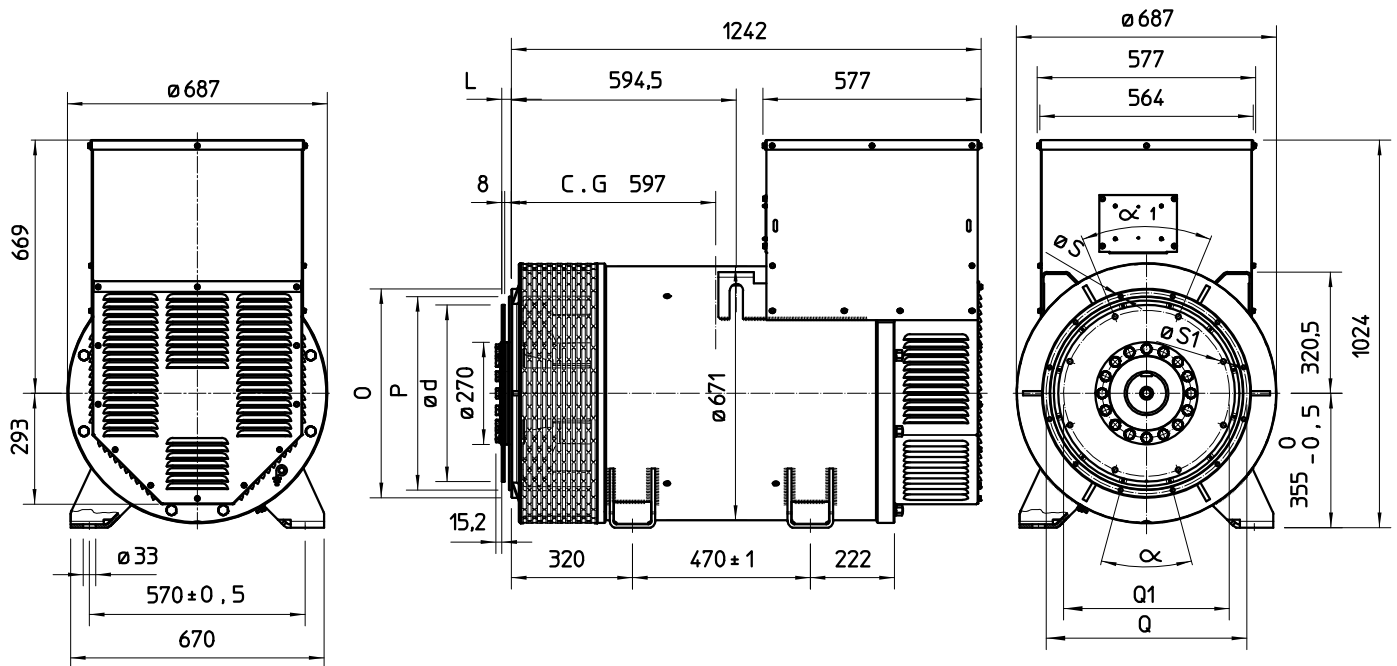

SAE N.	FLANGIA / FLANGE BRIDE / FLANSCH					
	O	P	Q	N. FORI	S	α
1	552	511,2	530,2	12	11	30°
1/2	648	584,2	619,1	12	14	30°
0	711	647,7	679,5	16	14	22,5°
00	883	787,4	850,9	16	14	22,5°

VOL. N.	GIUNTI A DISCHI / DISC COUPLING DISQUE DE MONOPALIER / SCHEIBENKUPPLUNG					
	L	d	Q1	N. FORI	S1	α1
14	25,4	466,72	438,15	8	14	45°
18	15,7	571,5	542,92	6	17	60°

C.G.= GRAVITY CENTER