

Electrical Characteristics										
Frequency	Hz	50				60				
Voltage (series star)	V	380	400	415	440	415	440	460	480	
Rated power class H	kVA	350	350	350	340	380	400	420	420	
	kW	280	280	280	272	304	320	336	336	
Rated power class F	kVA	320	320	320	310	350	370	385	385	
	kW	256	256	256	248	280	296	308	308	
Regulation with UVR6		±1 % with any power factor and speed variations between -5% +30%								
Insulation class		H								
Execution		Brushless								
Stator winding		12 ends								
Rotor		with damping cage								
Efficiencies class H	4/4	%	93,5	93,6	93,3	93,1	93,7	94,2	94,3	94,4
(see graph. for details)	3/4	%	93,5	93,8	93,7	93,4	94	94,2	94,4	94,6
	2/4	%	92,6	92,7	92,7	92,5	93,1	93,2	93,3	93,4
	1/4	%	90,2	90	89,8	89,6	90,7	90,7	90,7	90,5
Reactances (f. l.cl. F)	Xd	%	282,5	255	236,9	204,7	308,6	289,0	277,7	255
	Xd'	%	19,9	18,0	16,7	14,5	21,8	20,4	19,6	18,0
	Xd''	%	10,9	9,8	9,1	7,9	11,9	11,1	10,7	9,8
	Xq	%	146,3	132	122,6	106,0	159,8	149,6	143,7	132
	Xq'	%	146,3	132	122,6	106,0	159,8	149,6	143,7	132
	Xq''	%	23,3	21	19,5	16,9	25,4	23,8	22,9	21
	X <sub>2</sub>	%	18,2	16,4	15,2	13,2	19,9	18,6	17,9	16,4
	X <sub>0</sub>	%	2,5	2,3	2,1	1,8	2,8	2,6	2,5	2,3
Short Circuit Ratio	Kcc		0,35	0,40	0,55	0,90	0,22	0,30	0,35	0,40
Time Constants	Td'	sec.	0,102							
	Td''	sec.	0,0138							
	Tdo'	sec.	1,60							
	Tα	sec.	0,015							
Short Circuit Current Capacity		%	>300				>350			
Excitation at no load	Amp.		0,5	0,7	0,9	1,2	0,3	0,35	0,47	0,65
Excitation at full load	Amp.		3	3,2	3,4	3,5	2,4	2,6	2,8	3
Overload (long-term)		%	1 hour in a 6 hours period 110% rated load							
Overload per 20 sec.		%	300							
Stator Winding Resistance (20°C)	Ω		0,0044							
Rotor Winding Resistance (20°C)	Ω		3,960							
Exciter Resistance (20 °C)	Ω		Rotor : 0,410				Stator : 15,28			
Heat dissipation at f.l.cl.H	W		19465	19145	20107	20159	20440	19703	20310	19932
Telephone Interference			FHT < 2%				TIF < 40			
Radio interference			EN50081-1, EN50082-1, VDE0875K. For others standards apply to factory							
Waveform Distors.(THD) at f. load	LL/LN %		3,1 / 2,9							
Waveform Distors.(THD) at no load	LL/LN %		2,7 / 2,7							
<b>Mechanical characteristics</b>										
Protection			IP 21 (other protection on request)							
DE bearing			6318.2RS							
NDE bearing			6314.2RS							
Weight of wound stator assembly	kg		363							
Weight of wound rotor assembly	kg		240							
Weight of complete generator	kg		930							
Maximun overspeed	rpm		2250							
Unbalanced magnetic pull at f.l.cl.F	kN/mm		6,2							
Cooling air requirement	m <sup>3</sup> /min		32				39			
Inertia Constant (H)	sec.		0,125				0,150			
Noise level at 1m/7m	dB(A)		82 / 69				86 / 73			

**50 Hz**

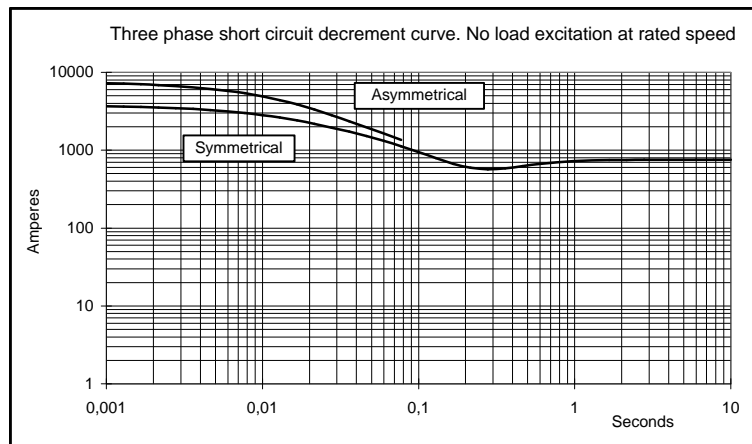

**60 Hz**

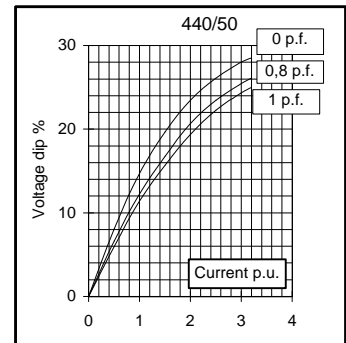
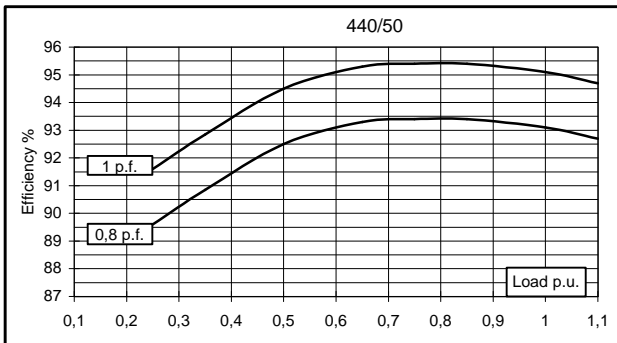
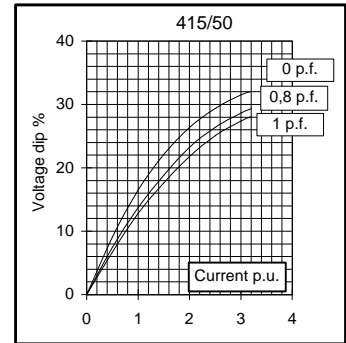
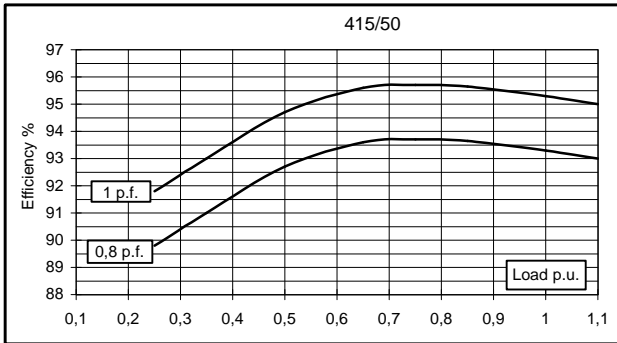
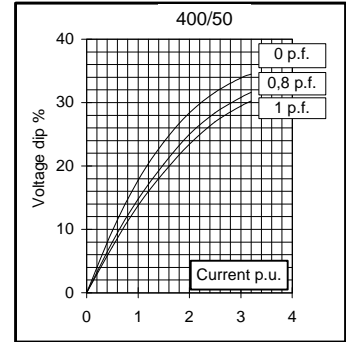
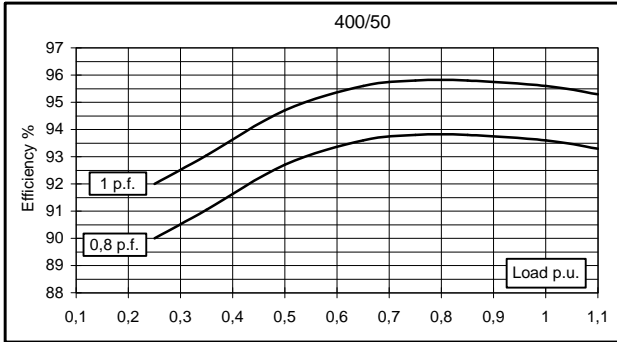
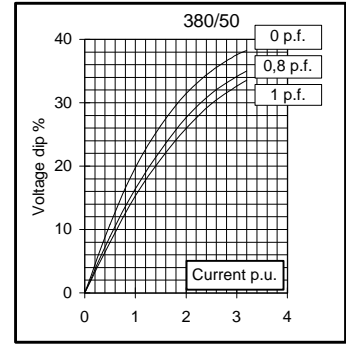
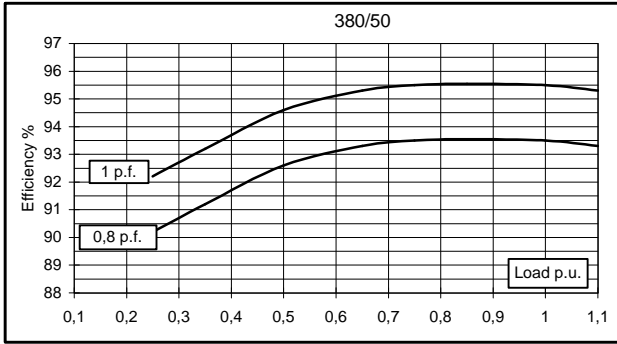
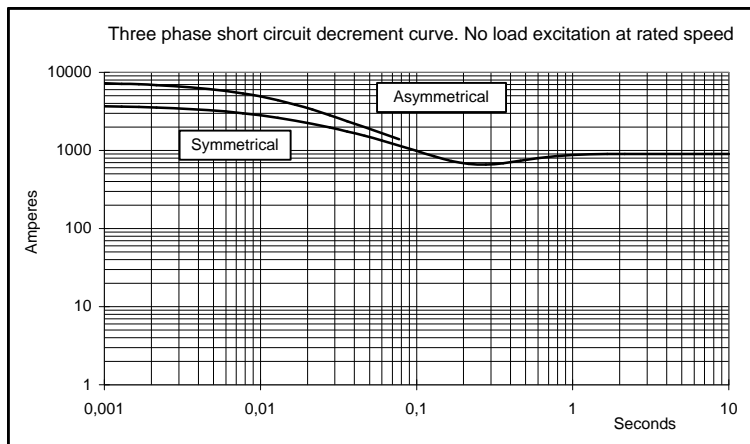
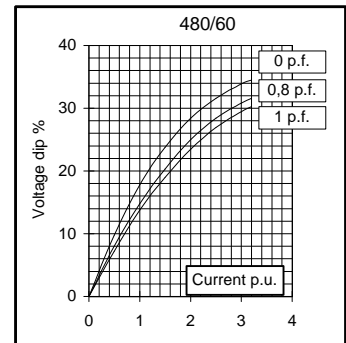
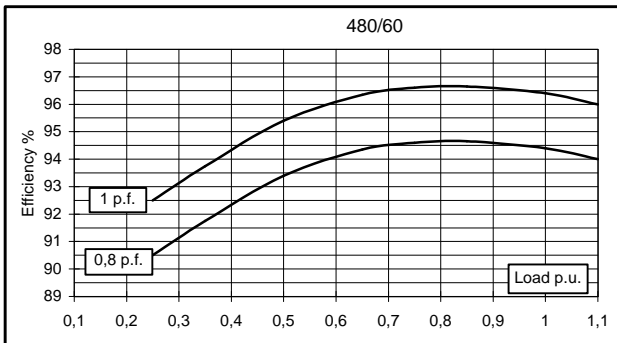
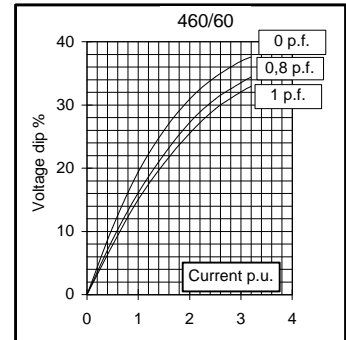
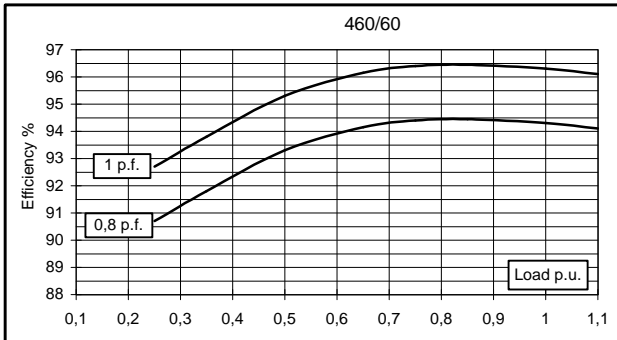
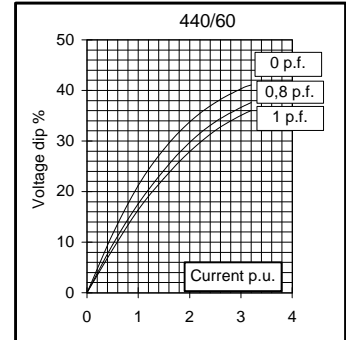
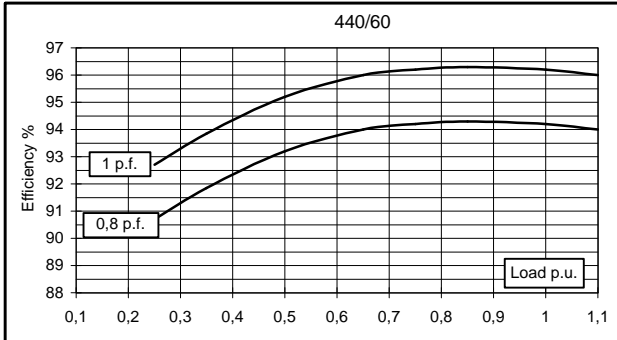
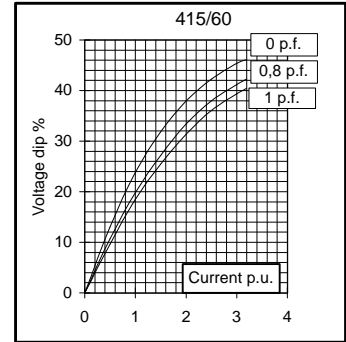
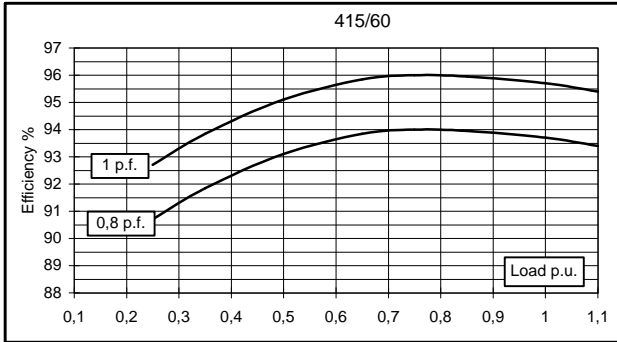



### SINGLE BEARING MOMENTS OF INERTIA

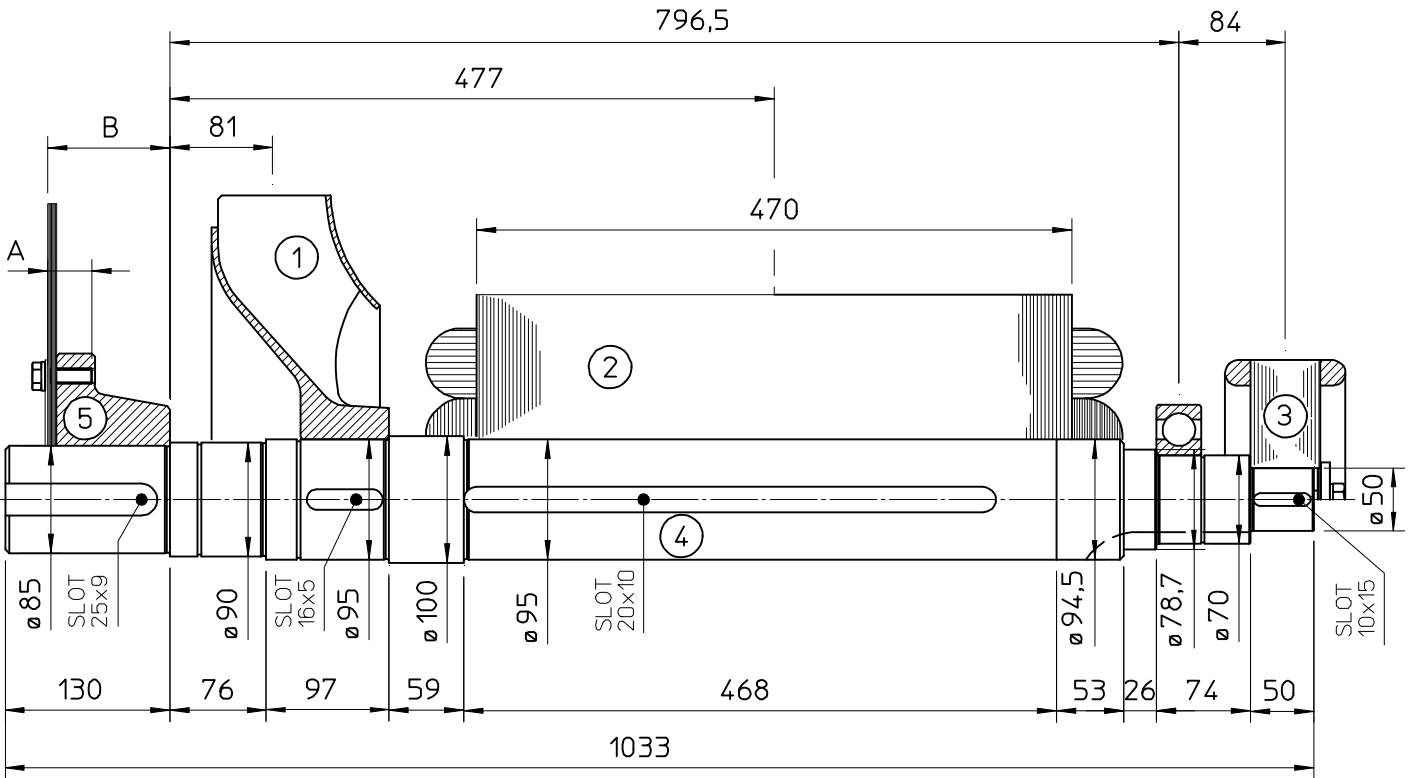

COMPONENT	WEIGHT kg	J kgm <sup>2</sup>
1 FAN	6,1	0,1887
2 MAIN ROTOR	240	3,2016
3 EX. ROTOR	14,5	0,0874
4 SHAFT	49,9	0,0525
TOTAL	310,5	3,5302

SAE No	SHAFTS COUPLING FLEX PLATE			
	A	B	WEIGHT kg	J kgm <sup>2</sup>
5				
11.5	41.1	110.4	22,7	0,306
14	34.7	96.4	22,7	0,306

### SINGLE BEARING DIMENSIONS

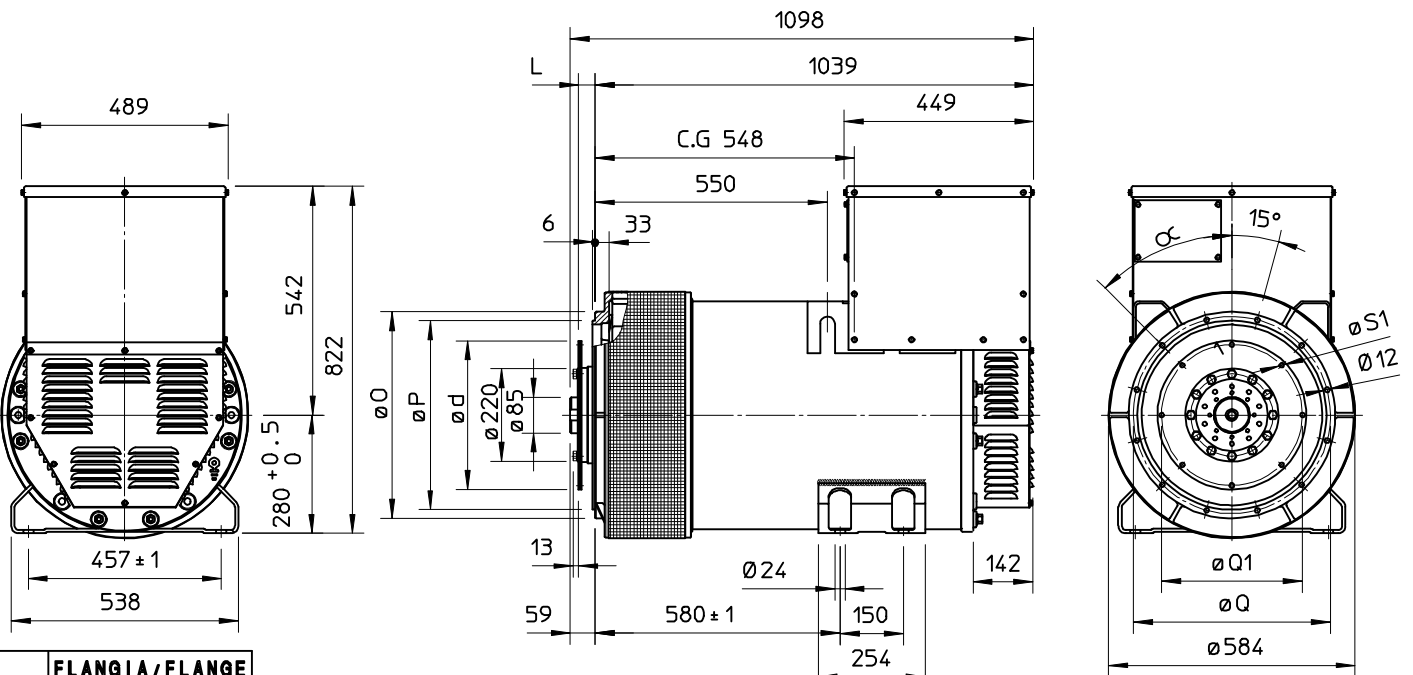

SAE N.	FLANGIA/FLANGE BRIDE/FLANSCH		
	O	P	Q
3	451	409,6	428,6
2	489	447,7	466,7
1	552	511,2	530,2
1/2	648	584,2	619,1

SAE N.	GIUNTI A DISCHI DISC COUPLING DISQUE DE MONOPALIER SCHEIBENKUPPLUNG					
	L	d	Q1	n. fori	S1	α1
11 1/2	39,6	352,42	333,37	8	11	45°
14	25,4	466,72	438,15	8	14	45°

C.G = GRAVITY CENTER