



GENERATOR TYPE ECO 32-3L/4

Document : **DS010A/1**
issue 008 date 03/04/2013

Electrical Characteristics										
Frequency	Hz	50				60				
Voltage (series star)	V	380	400	415	440	415	440	460	480	
Rated power class H	kVA	75	75	75	70	80	86	90	90	
	kW	60	60	60	56	64	69	72	72	
Rated power class F	kVA	67	67	67	62	73	80	83	83	
	kW	53,6	53,6	53,6	49,6	58,4	64	66,4	66,4	
Regulation with	DSR	±1 % with any power factor and speed variations between -5% +30%								
Insulation class		H								
Execution		Brushless								
Stator winding		12 ends								
Rotor		with damping cage								
Efficiencies class H	4/4	%	90,6	90,7	90,4	90,2	92,5	93	93,1	93,2
(see graph. for details)	3/4	%	90,8	91,1	91	90,7	92,8	93	93,2	93,4
	2/4	%	89,6	89,7	89,7	89,7	90,8	90,9	91	91,1
	1/4	%	87,1	86,9	86,7	86,4	88,1	88,1	88,1	87,9
Reactances (f. l.cl. F)	Xd	%	338,3	305,4	283,7	235,5	363,1	347,2	332,5	305,4
	Xd'	%	14,84	13,4	12,44	10,33	15,93	15,23	14,58	13,4
	Xd''	%	7,72	7	6,47	5,37	8,28	7,92	7,58	7
	Xq	%	130,6	117,9	109,5	90,9	140,1	134,0	128,3	117,9
	Xq'	%	130,6	117,9	109,5	90,9	140,1	134,0	128,3	117,9
	Xq''	%	38,0	34,3	31,9	26,4	40,8	39,0	37,3	34,3
	X ₂	%	25,88	23,4	21,70	18,02	27,77	26,56	25,43	23,4
	X ₀	%	3,68	3,3	3,09	2,56	3,95	3,78	3,62	3,3
Short Circuit Ratio	Kcc		0,48	0,57	0,64	1,19	0,36	0,40	0,48	0,57
Time Constants	Td'	sec.	0,065							
	Td''	sec.	0,0135							
	Tdo'	sec.	1,30							
	Tα	sec.	0,027							
Short Circuit Current Capacity		%	>300				>350			
Excitation at no load	Amp.		0,5	0,6	0,7	1,2	0,25	0,3	0,4	0,5
Excitation at full load	Amp.		2,1	2,2	2,4	2,8	1,8	1,7	1,9	2,1
Overload (long-term)	%	1 hour in a 6 hours period 110% rated load								
Overload per 20 sec.	%	300								
Stator Winding Resistance (20°C)	Ω	0,035								
Rotor Winding Resistance (20°C)	Ω	3,171								
Exciter Resistance (20 °C)	Ω	Rotor : 0,442				Stator : 11,35				
Heat dissipation at f.l.cl.H	W	6225	6152	6372	6084	5189	5178	5336	5253	
Telephone Interference		THF < 2%				TIF < 45				
Radio interference		EN61000-6-3, EN61000-6-1. For others standards apply to factory								
Waveform Distors.(THD) at f. load	LL/LN %	3,9 / 3,7								
Waveform Distors.(THD) at no load	LL/LN %	3,3 / 3,1								
Mechanical characteristics										
Protection		IP 21 (other protection on request)								
DE bearing		6312-2RS								
NDE bearing		6309-2RS								
Weight of wound stator assembly	kg	110								
Weight of wound rotor assembly	kg	74								
Weight of complete generator	kg	298								
Maximun overspeed	rpm	2250								
Unbalanced magnetic pull at f.l.cl.F	kN/mm	5,2								
Cooling air requirement	m ³ /min	11,8				14,5				
Inertia Constant (H)	sec.	0,094				0,113				
Noise level at 1m/7m	dB(A)	75 / 60				79 / 64				

All technical data are to be considered as a reference and they can be modified without any notice.

This document is a propriety of Mecc Alte S.p.a..All rights reserved.

50 Hz

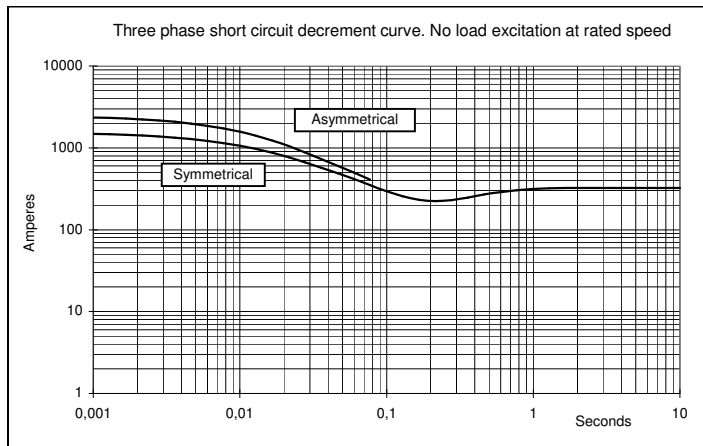
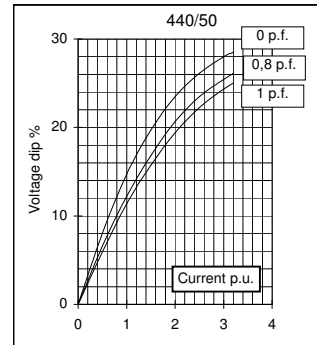
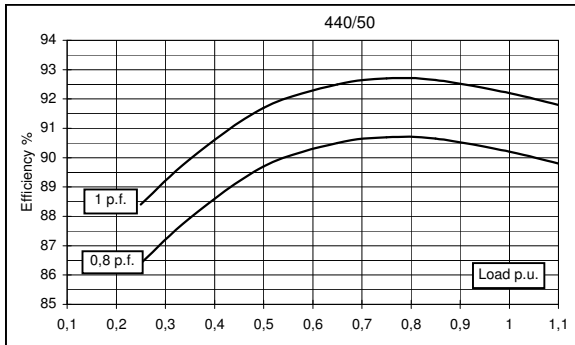
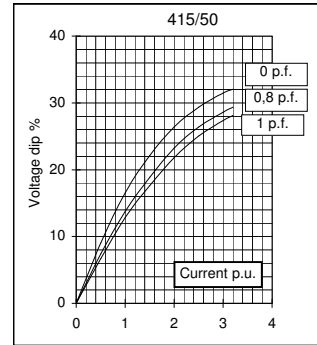
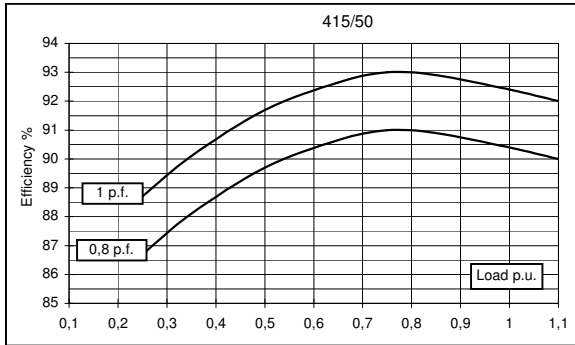
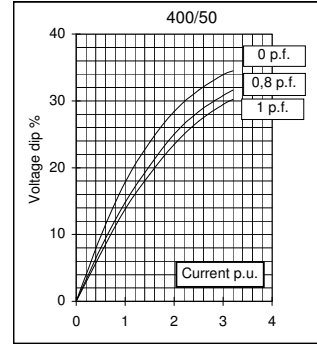
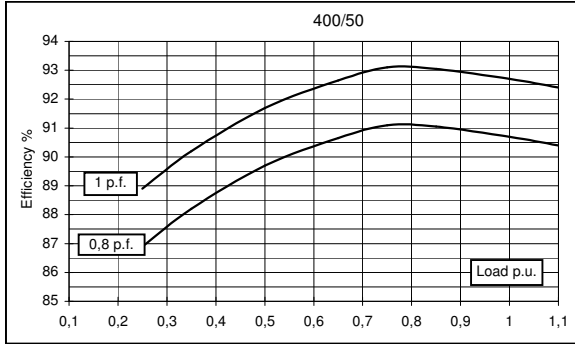
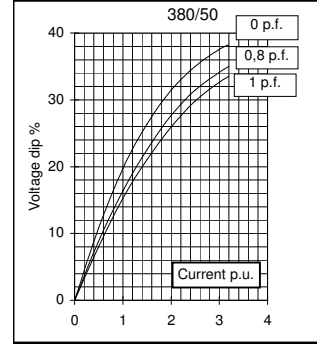
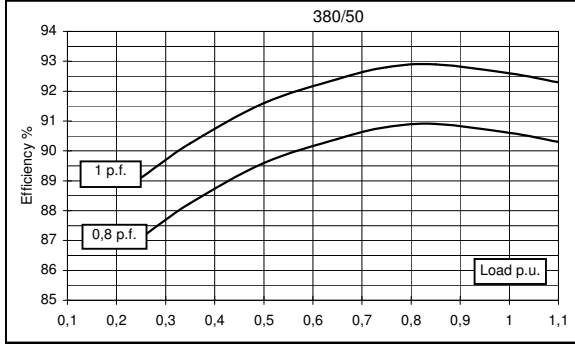

60 Hz

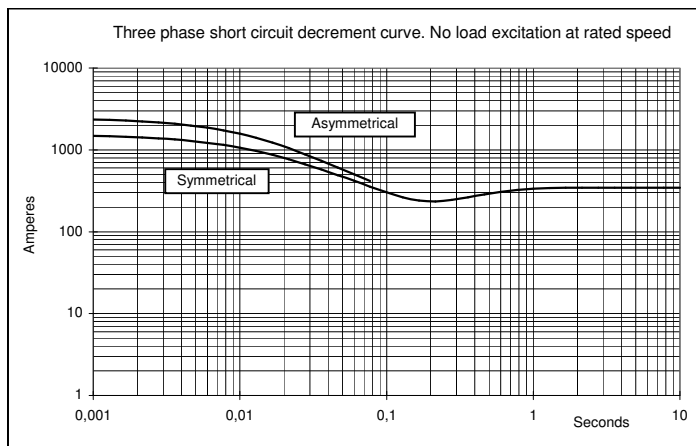
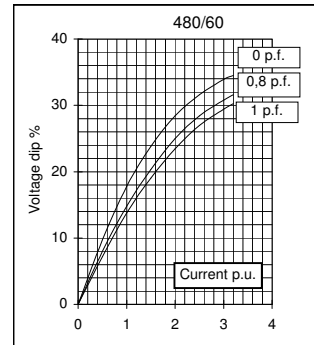
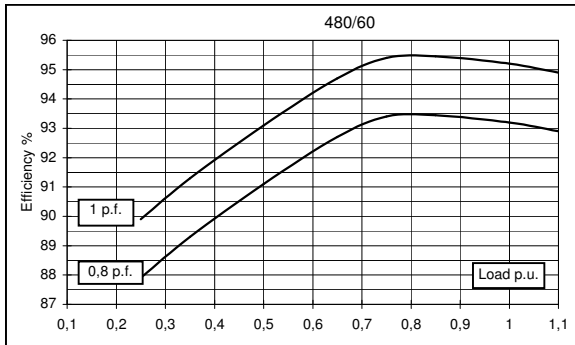
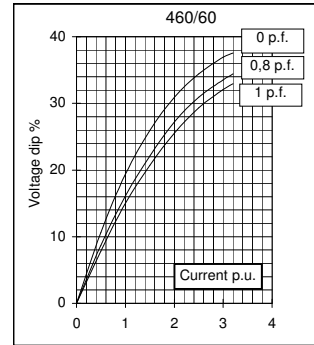
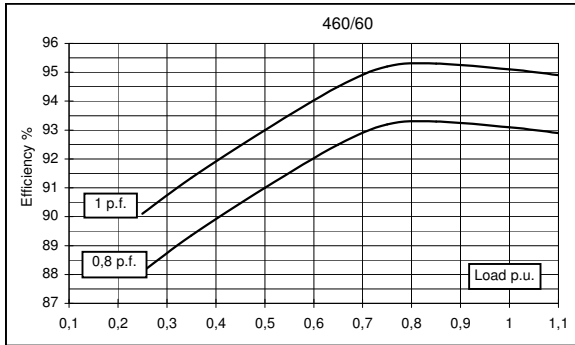
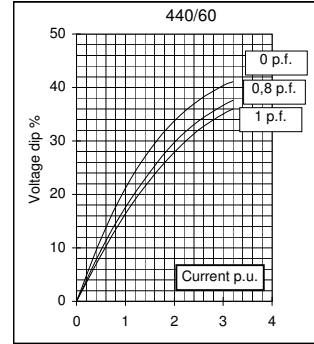
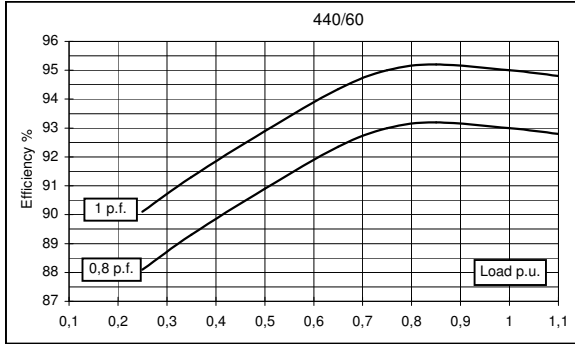
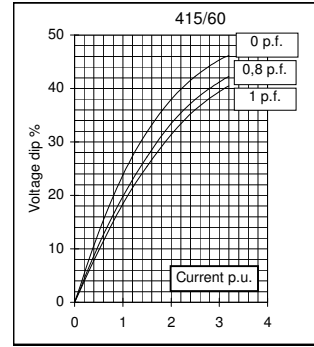
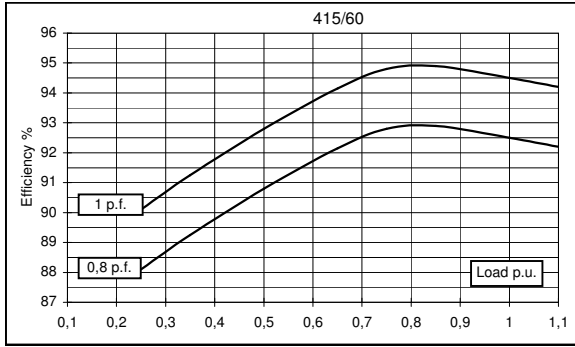

TWO BEARING MOMENTS OF INERTIA

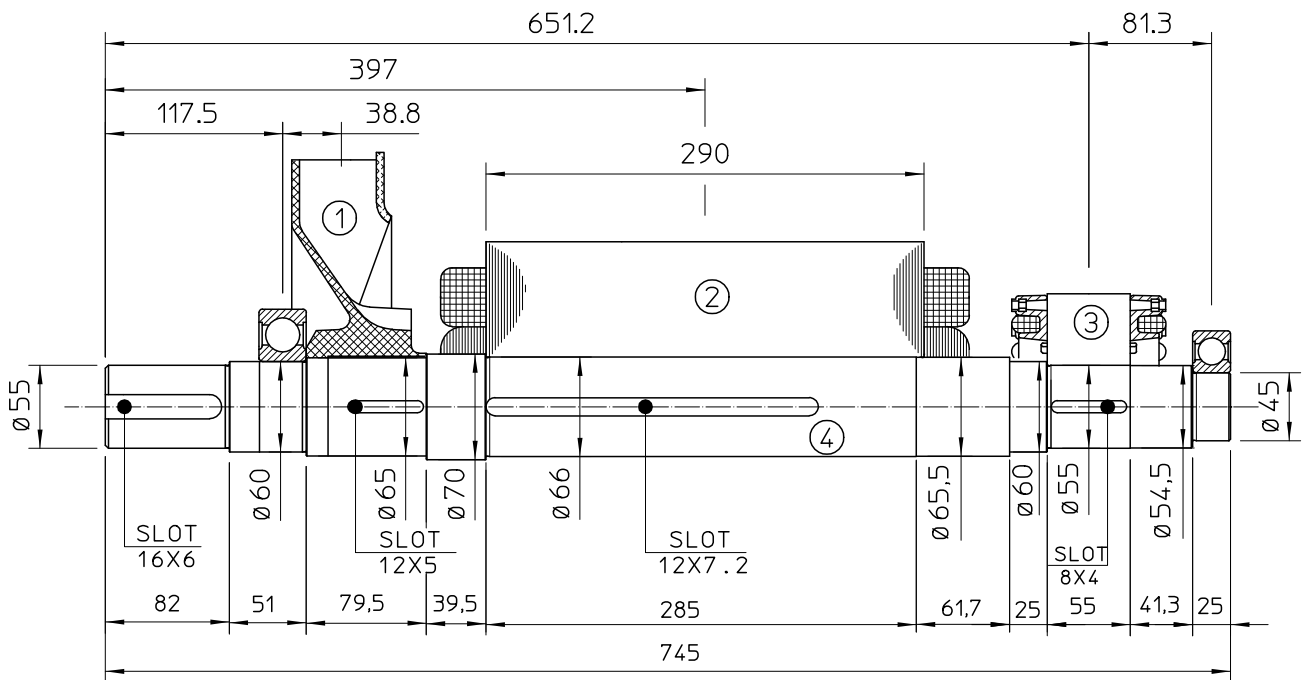

POS.	COMPONENT	WEIGHT (kg)	J (kgm ²)
1	FAN	2.3	0.0224
2	MAIN ROTOR	74	0.5254
3	EX. ROTOR	7	0.016
4	SHAFT	17.3	0.0067
TOTAL		100.6	0.5705

TWO BEARING DIMENSIONS

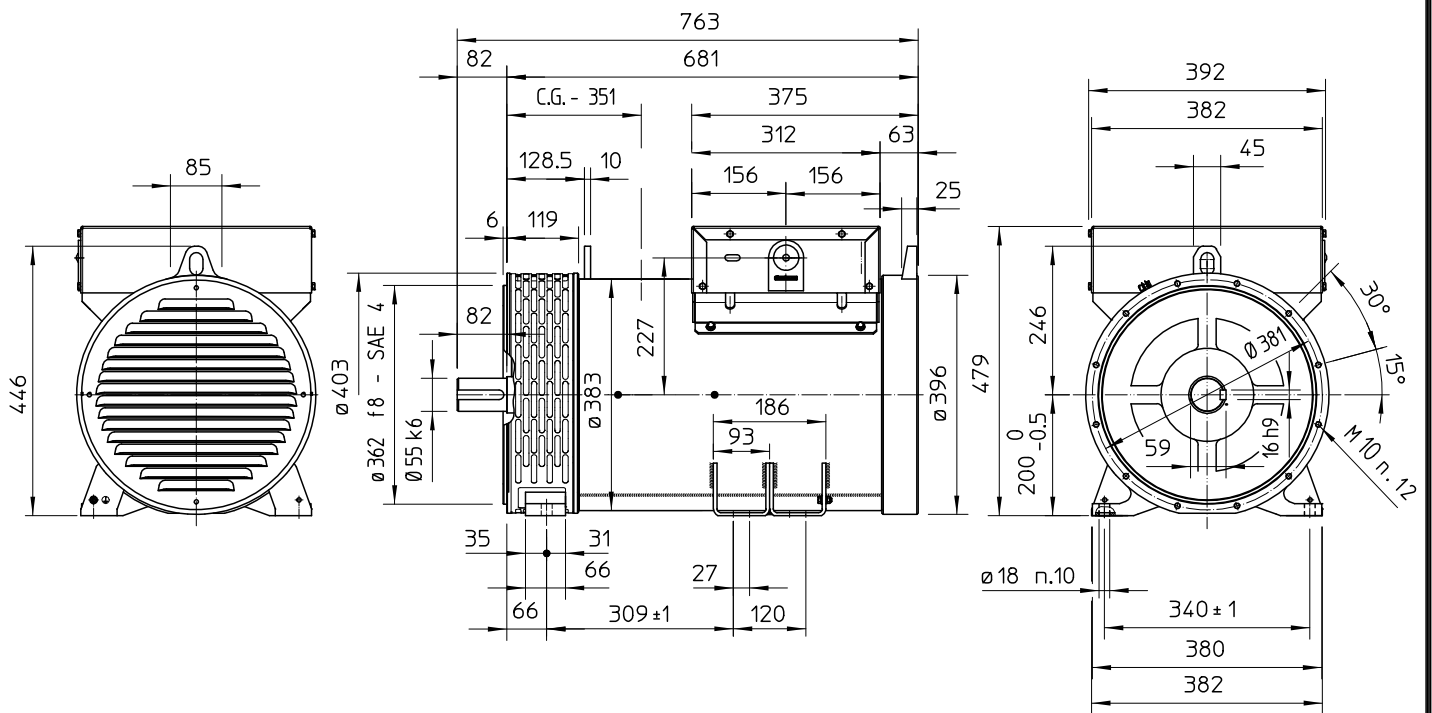

SINGLE BEARING MOMENTS OF INERTIA

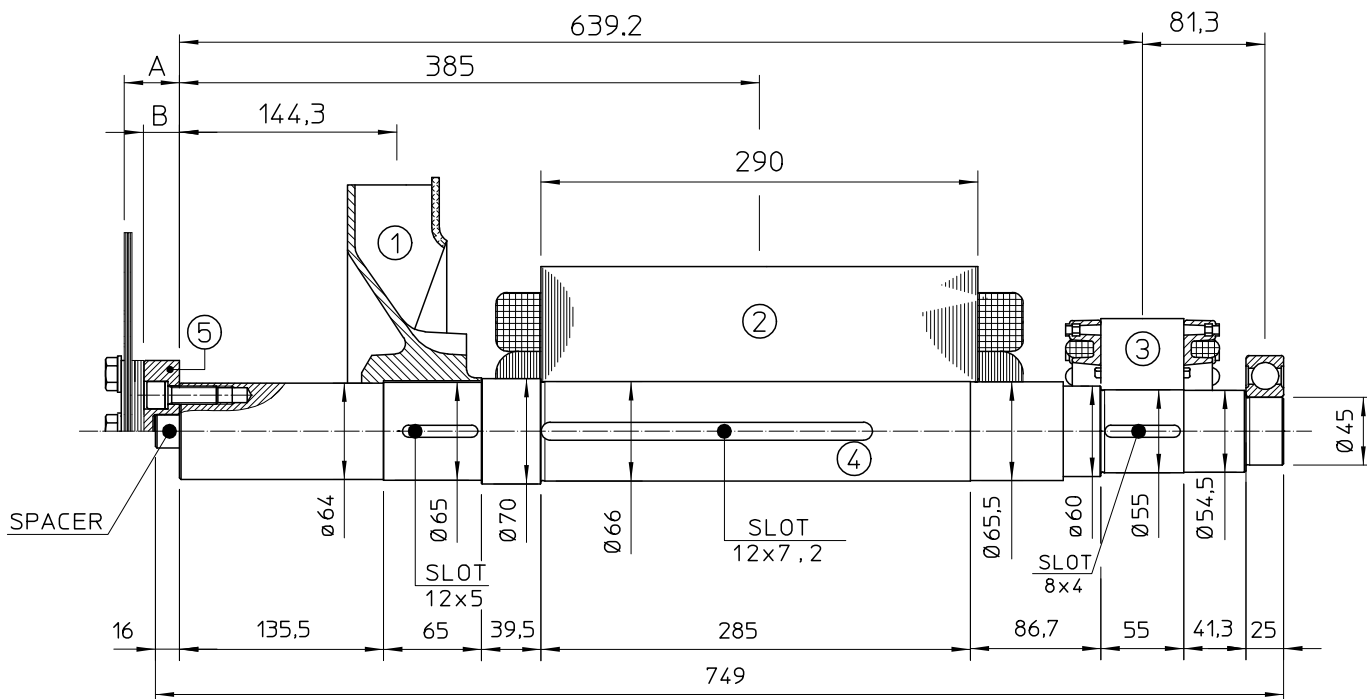

POS.	COMPONENT	WEIGHT (kg)	J (kgm ²)
1	FAN	2.3	0.0224
2	MAIN ROTOR	74	0.5254
3	EX. ROTOR	7	0.016
4	SHAFT	17.6	0.0090
TOTAL		100.9	0.5728

SAE N°	5		SHAFTS COUPLING FLEX PLATE	
	A	B	WEIGHT kg	J kgm ²
6.5	5	2.5	1.74	0.0084
7.5	5	2.5	2.1	0.013
8	36.6	28.1	3.9	0.02
10	28.6	21.6	4.47	0.038
11.5	15	11.5	4.51	0.059

SINGLE BEARING DIMENSIONS

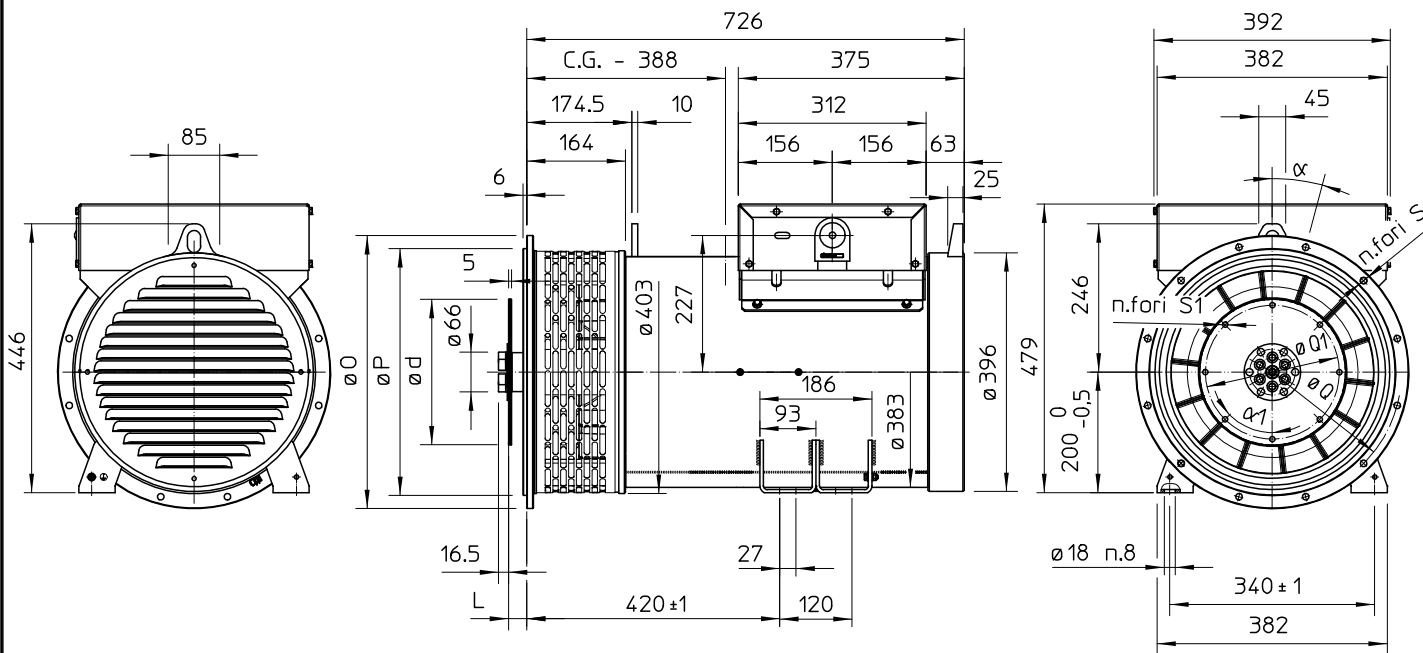

SAE N.	FLANGIA / FLANGE BRIDE / FLANSCH					
	O	P	Q	S	N. FORI HOLES N°	α
5	356	314.3	333.4	11	8	45
4	403	362	381	11	12	30
3	451	409.6	428.6	11	12	30
2	490	447.7	466.7	11	12	30
1	552	511.2	530.2	11	12	30

SAE N.	GIUNTI A DISCHI / DISC COUPLING DISCQUE DE MONOPALIER / SCHEIBENKUPPLUNG					
	d	L	Q1	S1	N. FORI HOLES N°	α1
6 1/2	215.9	30.2	200	9	6	60
7 1/2	241.3	30.2	222.25	9	8	45
8	263.52	62	244.47	11	8	60
10	314.32	53.8	295.27	11	8	45
11 1/2	352.42	39.6	333.37	11	8	45

C.G.= GRAVITY CENTER